

Spring Probe FKS-200

GRID: 2,54 mm / 100 mil

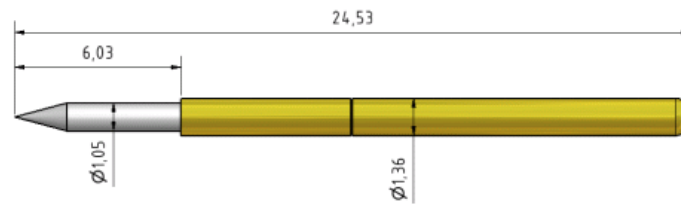







Technical Data







GRID:	2,54 mm / 100 mil
Working stroke:	2,54 mm
Maximum stroke:	4,0 mm
Contact resistance typical:	50 mΩ
Current rating:	3 A
Spring force at working stroke:	1,0 N 2,0 N 2,5 N

Material

Plunger:	BeCu, gold or rhodium plated
Barrel:	Brass, gold plated
Spring:	Music wire, gold plated

Tip styles for FKS-200

						
Tip No.:	01	02	03	04	05	06
Specifications:	-90°	30°			90°	
Tip diameter:	Ø 1,9	Ø 1,05	Ø 1,05	Ø 1,27	Ø 1,6	Ø 1,9
	Ø 1,52			Ø 1,9	Ø 1,9	
				Ø 2,54	Ø 2,54	
				Ø 3,5	Ø 3,5	
				Ø 3,96	Ø 3,96	

						
Tip No.:	07	08	09	12	14	17
Specifications:						
Tip diameter:	Ø 1,05	Ø 1,6	Ø 1,05	Ø 1,6	Ø 1,6	Ø 1,6
		Ø 1,8		Ø 1,9	Ø 1,9	Ø 1,9
		Ø 1,9		Ø 2,54		
		Ø 2,54		Ø 3,0		
		Ø 3,5		Ø 3,5		
		Ø 3,96		Ø 3,96		

	
Tip No.:	18
Specifications:	
Tip diameter:	Ø 1,6
	Ø 1,9

Further tip styles on demand.

Receptacle for FKS-200

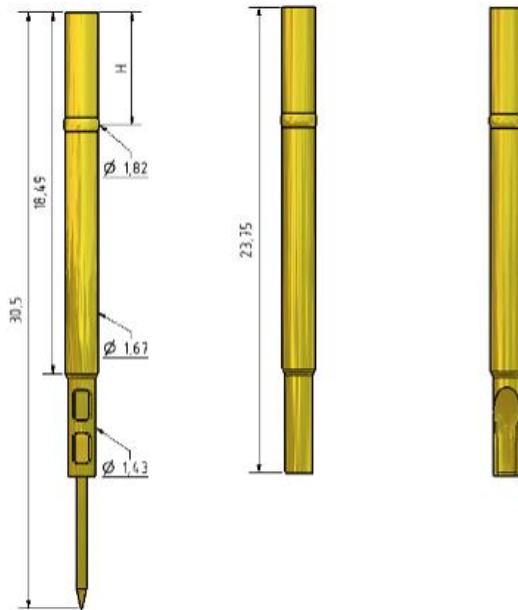

Version: SH-200-P-W SH-200-P-C SH-200-P-L

Material: Phosphor bronze or brass, gold plated

Mounting hole size: 1,75 mm (with receptacle)