

[Datenblatt herunterladen \(PDF\)](#)

## Federkontaktstift HFKS-440

Rastermaß: 4,00 mm / 160 mil

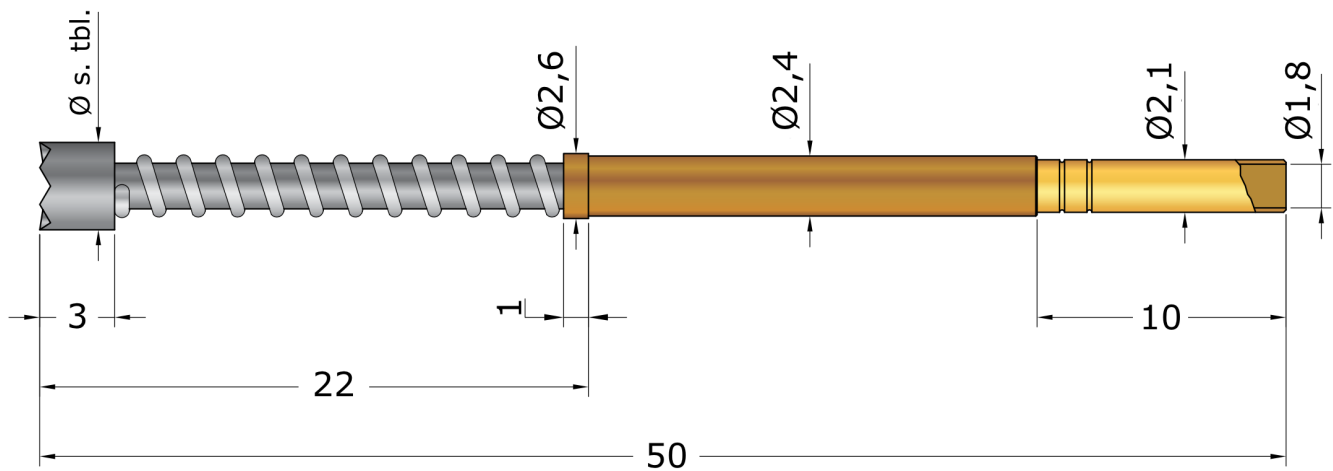







### Technische Daten

<b>Rastermaß:</b>	4,00 mm / 160 mil
<b>Arbeitshub:</b>	6,4 mm
<b>Maximaler Hub:</b>	8,0 mm
<b>Übergangswiderstand typisch:</b>	<10 mΩ
<b>Nennstrom:</b>	16 A
<b>Mögliche Federkräfte:</b>	2,0 N 4,0 N

### Material

<b>Kolben:</b>	Stahl, vergoldet oder vernickelt
<b>Gehäuse:</b>	Bronze, unbeschichtet
<b>Feder:</b>	Edelstahl
<b>Temperatureinsatzbereich:</b>	-50° bis zu +100°

## Mögliche Kopfformen für HFKS-440

						
<b>Kopfform Nr.:</b>	01	04	06	08	08	12
<b>Spezifikation:</b>	-90°				Waffel - fein	
<b>Kopfdurchmesser:</b>	∅ 3,50	∅ 3,50	∅ 3,50	∅ 1,80	∅ 2,30	4,00
				∅ 3,00	∅ 4,00	
				∅ 4,00	∅ 6,50	

Weitere Kopfformen auf Anfrage.

## Mögliche Hülsen für HFKS-440

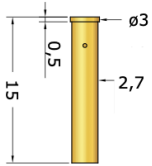

HSH-440

Material: Messing, vergoldet

Montagebohrung: 2,69 - 2,70 mm (mit Hülse)

Download:

Änderungen vorbehalten